

# Grappin à polype pour ferraille et déchets en général

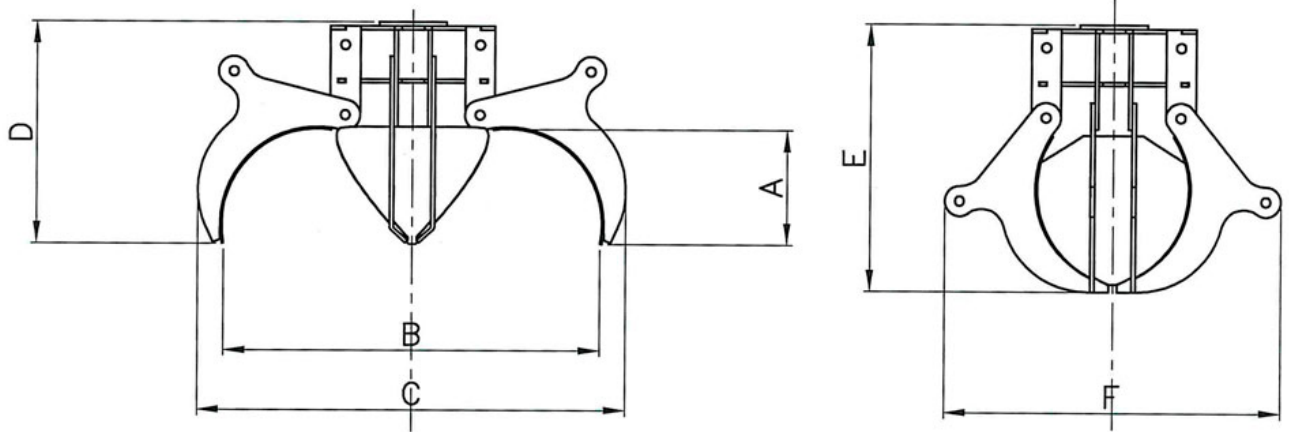

## Fiche Technique









MODELE	N° Dents	VOLUME dm <sup>3</sup>	Poids Kg	MAX bar	A mm	B mm	C mm	D mm	E mm	F mm
POLY 4 - 100 - 4 Dents	4	30	124	200	310	1025	1142	572	695	899
POLY 4 - 125 - 4 Dents	4	55	145	200	369	1278	1406	631	835	899
POLY 4 - 150 - 4 Dents	4	102	167	200	409	1496	1612	669	899	940

## Accessoires:

[\\*Accessori per pinze per tronchi, pinze da roccia, benna mordente, pinze con motosega, pinze selezionatrice, polipi per legna/rottami](#)

[\\*Accessori ROTATORI per pinze tronchi, pinze da roccia, benna mordente, pinze con motosega, pinze selezionatrice, polipi per legna/rottami](#)

	Rotori per uso orizzontale/verticale per pinze mod. RF
	Rotori ad uso pendolare per pinze mod. RP
	Forcella (su misura per mod. RF)
	Forcella (su misura per mod. RP)
	Valvola di MASSIMA per pressioni superiori ai 200 BAR
	Kit Benne per pinze modello comby
	Attacco rapido (specificare modello)